

BASTEEL

PERIMETER SYSTEMS™

BASTEEL PERIMETER SYSTEMS
 1400 MAGNOLIA AVE.
 FRANKFORT, IN 46041
 TOLL FREE: 1-866-369-8335
 FAX: (765) 654-8755
 www.basteel.com

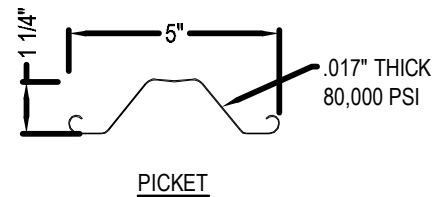
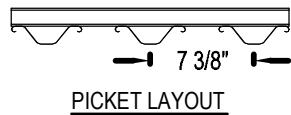
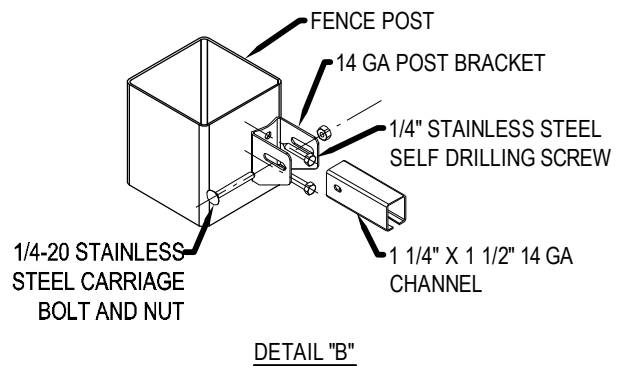
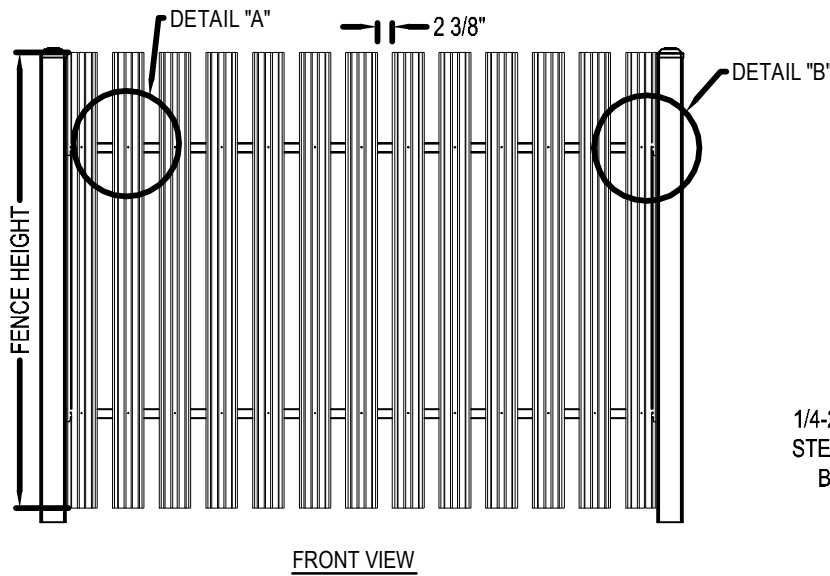
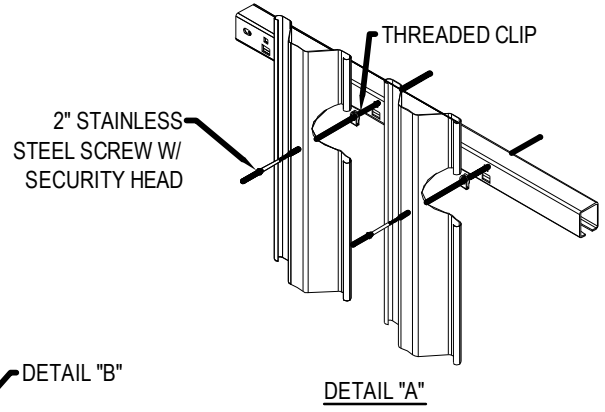
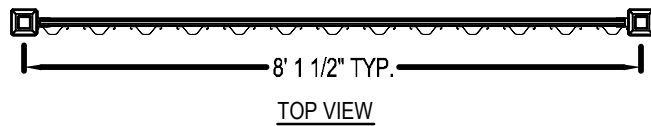

NOTES:

1. MATERIALS OF CONSTRUCTION ARE GALVANIZED STEEL EXCEPT WHERE NOTED.
2. BASTEEL STANDARD COLORS COATED USING ORGANIC FLUOROPOLYMER (KYNAR).
3. INSTALLATION TO BE COMPLETED IN ACCORDANCE WITH MANUFACTURER'S SPECIFICATIONS.
4. DO NOT SCALE DRAWING.
5. THIS DRAWING IS INTENDED FOR USE BY ARCHITECTS, ENGINEERS, CONTRACTORS, CONSULTANTS AND DESIGN PROFESSIONALS FOR PLANNING PURPOSES ONLY. THIS DRAWING MAY NOT BE USED FOR CONSTRUCTION.
6. ALL INFORMATION CONTAINED HEREIN WAS CURRENT AT THE TIME OF DEVELOPMENT BUT MUST BE REVIEWED AND APPROVED BY THE PRODUCT MANUFACTURER TO BE CONSIDERED ACCURATE.
7. CONTRACTOR'S NOTE: FOR PRODUCT AND COMPANY INFORMATION VISIT www.CADdetails.com/info AND ENTER REFERENCE NUMBER 5074-002.

